

KAHUNA  CHAIR®

---

KAHUNA MASSAGE CHAIR  
**LM 6800**  
**MANUAL**

---





## CONTENTS



Please read and follow all safety and operating instructions listed in this user manual prior to use. Basic precautions should always be used when operating an electrical appliance.





Safety Instructions	.....	2
Product Components	.....	7
Chair Installation	.....	9
Remote Controller	.....	15
Operation Guide	.....	16
Troubleshooting	.....	22
Maintenance	.....	23
Product Specifications	.....	24

# SAFETY INSTRUCTION

- Please read this manual carefully to make sure the installation and operation of the massage chair is correct.
- “Safety Instructions” are provided in both Warning and Caution for important safety information.

Both Warning and Caution are important safety caution, please be more cautious.

 Warning	This sign indicates warning of causing possible death or hurt to body.
 Caution	This sign indicates caution of causing possible pain or damage to body.

	This sign indicates forbidden behavior.
	This sign indicates must follow instruction to operate.
	This sign indicates self disassembly is forbidden.
	This sign indicates correct operation of cable.

- The following should be kept for any further references.



## Warning

	<ul style="list-style-type: none"> <li>• Osteoporosis patient ;</li> <li>• People with heart disease including embedded pacemaker or other medical electronic device inside the body ;</li> <li>• For pregnant women or people with health issues, please consult doctor before use ;</li> <li>• Patients with a high fever forbid to use this machine.</li> <li>• Perceptual disabilities patients forbid to use this machine.</li> <li>• People over 80 years old forbid to use this machine.</li> <li>• Kids and the drunk people are not allowed to use the chair ;</li> <li>• Please don't sleep in the chair.</li> <li>• Don't use the chair when your body is wet.</li> </ul>	<p>People who are not suitable to use the chair</p>
	<ul style="list-style-type: none"> <li>• Make sure there are no kids or pets or other objects around (under, behind or in front of) the chair at the moment of backrest, leg-rest up/down or leg-rest retraction/extension from reclining position.</li> <li>• During operation, if body is being abnormal, please stop the operation and go consult with your physician.</li> <li>• Please do not take strong massage on the head.</li> <li>• Do not massage belly or knees, be careful when massaging neck</li> <li>• Children or pets are not allowed to play on the chair especially during massage. Standing or sitting on the back or armrest is not allowed either.</li> <li>• Those who move around with difficulty or can't express themselves must be taken care of strictly and continuously during massage.</li> </ul>	<p>Accident /injury</p>
	<ul style="list-style-type: none"> <li>• Insert the plug of the chair into correct and suitable power socket.</li> <li>• Make sure the plug is completely inserted into the socket to reduce short circuit or fire risk.</li> <li>• Unplug the power when not in use, stop all massage functions and turn off on/off key before unplugging.</li> </ul>	<p>Fire and electric shock</p>
	<ul style="list-style-type: none"> <li>• Massage cushions of the chair are not allowed to fold for storage.</li> <li>• The machine is forbidden for no-load running for a long time.</li> <li>• Power cord, plug, socket can't be used in broken or loose contact condition.</li> <li>• Don't use other electric power except rated voltage in case of fire, electric shock or any breakdown.</li> <li>• Any broken, re-process, knotted, twisted power cord or pressed under heavy cargo is not allowed to use.</li> </ul>	<p>Accident</p> <p>Fire and electric shock</p>

# SAFETY INSTRUCTION



## Warning



	<ul style="list-style-type: none"> <li>• If the chair is dysfunctional, or is broken, splashed with water or falls into water, please have it repaired by professional repairman or send the chair to assigned service agent. Self-modification, disassembly or maintenance is forbidden.</li> <li>• If power cord or plug is damaged, please don't replace it yourself, please contact us or appointed dealer for replacement.</li> <li>• To avoid electric shock or body injury, please don't open or disassemble any part of the chair, there is not any attached part of the chair for maintenance by customers.</li> <li>• Check leather or cloth material on the back and other areas is broken or not. If broken, even though it is small, please stop using the chair, unplug the power and have it repaired.</li> </ul>	<p>Disassembly and maintenance</p>
--	--	------------------------------------



## Caution

	<ul style="list-style-type: none"> <li>• Please operate the chair when it is flat or on leveled place</li> <li>• Position the chair 4 inches from the wall to allow for sufficient space to recline up and down.</li> <li>• The maximum suggested operating time is 20 mins. 5 mins for each position beginning with the slight- step massage. Along continuous massage in the same position may cause uncomfortable feeling.</li> <li>• Before sitting on the chair to avoid injury please inspect everything to confirm that the massage heads are in the correct position.</li> <li>• Please make sure that the power switch is on "OFF" position before inserting the plug into the socket.</li> <li>• Turn off all controls before removing plug from outlet.</li> <li>• Make sure the plug is completely inserted into the socket.</li> <li>• Checking whether there are any damages on the wire and make sure there are no water or rubbish on the wire.</li> <li>• Installing the wire in a correct way. The plug must be inserted into socket with  the connect, the connect couldn't be bent or cut off.</li> </ul>	<p>To avoid sudden falling.</p> <p>To make sure the back lying.</p> <p>Too long time massage is bad for your body.</p> <p>To avoid accidental injury.</p> <p>To avoid the accident when turn on the power.</p> <p>To reduce short circuits and any fire hazard.</p> <p>To avoid electric shock in any leakage or breakdown.</p>
	<ul style="list-style-type: none"> <li>• Don't use or store the chair in the wet environment like near the swimming pool, or bathroom.</li> <li>• Keep the chair and remote control dry at all time.</li> <li>• Don't use the chair when your body is wet.</li> </ul>	<p>To avoid leakage or electric shock.</p>

## Caution

	<ul style="list-style-type: none"> <li>• Don't press with hands or step on the massage heads with feet.</li> <li>• Don't put hands between the working massage heads. Don't put hands or feet in the gap of mechanical parts. Don't drop or insert anything into the slot of massage chair.</li> <li>• Don't stand or sit or put anything on the backrest, armrest, or leg-rest.</li> <li>• Don't stand on the chair during operation. Don't move the chair during operation.</li> <li>• Don't pull out the plug or turn off the power during operation. Don't put your hands or head between leg-rest or beneath. Don't use the massage chair while wearing hair ornaments.</li> <li>• Don't put hard things in pocket when take buttocks and huckle massage.</li> <li>• Don't sit or press on the backrest when the chair is in reclining position.</li> <li>• Don't use on bare skin or wearing thin clothes, thin clothes may cause better massage effect, But it also may cause irritation to the skin or cryogenic burns.</li> </ul>	<p>To avoid accidents or injury</p>
	<ul style="list-style-type: none"> <li>• Keep the chair away from heat, wet, sharp things and corrosive, inflammable, explosive environment.</li> <li>• To use electric blanket or other heating products on the chair is forssiden.</li> <li>• Don't put in the space of dust serious or corrosive gas environment.</li> <li>• Don't put the chair in a small space places or use in the bad air circulation places.</li> </ul>	<p>To avoid fade, discolor on upholstery or hardened, deteriorated on PU.</p>
	<ul style="list-style-type: none"> <li>• Keep the chair away from stove or other heating products.</li> <li>• Don't put the chair directly under the sun or other high temperature places.</li> <li>• Don't use the chair in outdoor.</li> <li>• Make sure to install the wire in correct way(Incorrect install way may cause electric shock. If you don't know how to install, please find a professional electrician)</li> <li>• Don't use plug adapter (If the enclosed plug doesn't match with socket, please don't change the plug by yourself and find a professional electrician to install a matched socket.)</li> </ul>	<p>To avoid electric shock.</p>

# SAFETY INSTRUCTION

## Caution

	<ul style="list-style-type: none"> <li>• Unplug the power before cleaning the chair.</li> <li>• Unplug the power after using the chair.</li> </ul>	To avoid electric shock or fire hazard.
	<ul style="list-style-type: none"> <li>• Unplug the power when any damage on the power.</li> </ul>	
	<ul style="list-style-type: none"> <li>• Hold the plug to unplug the power but to not try to pull the wire to unplug the power.</li> </ul>	To avoid accidents
	<ul style="list-style-type: none"> <li>• Please turn off the power switch and unplug the power after massage.</li> </ul>	
	<ul style="list-style-type: none"> <li>• Unplug the power immediately when electricity goes off.</li> </ul>	



- Warning :**
1. Do not use it when gets wet.
  2. The disabled or people who need supervision.
  3. The chair has heat function, people who are insensitive to heat must pay high attention.

## | Grounding instruction |

The chair is equipped with a cord having a grounding conductor. The plug must be plugged into an appropriate socket that is properly installed and matched with the plug.



Earth wire is not allowed to be in these places

Gas pipe: probably cause explosion or fire.  
 Phone wire and lightning rod: probably cause electric shock and fire when thundering.  
 Water pipe: earth wire is useless where there are plastics

## | Main Body Diagram (Front) |

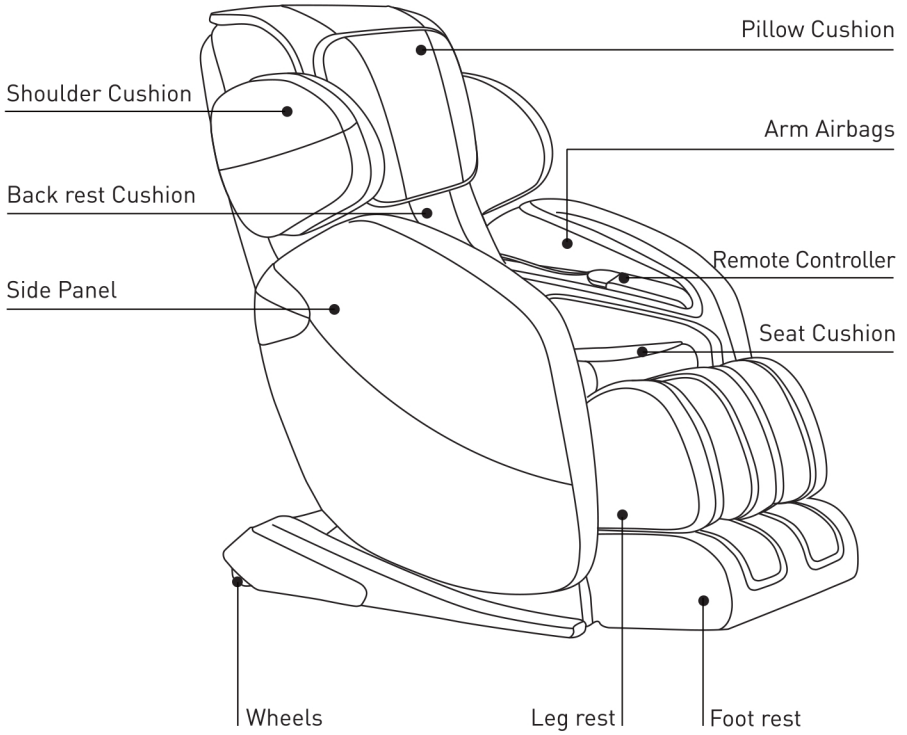

# PRODUCT COMPONENTS

## | Main Body Diagram (Rear) |

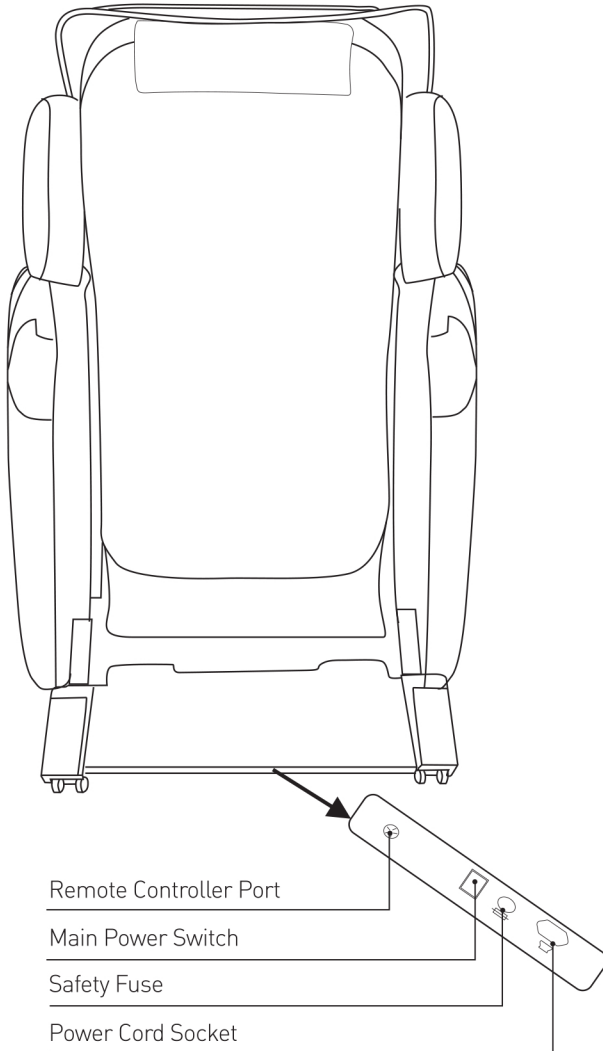

# CHAIR INSTALLATION

## 1. Remove the package and take out the spare parts |

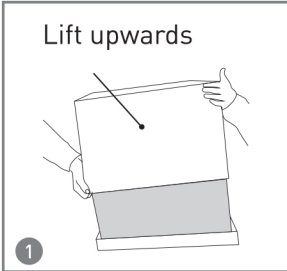

Remove the carton.

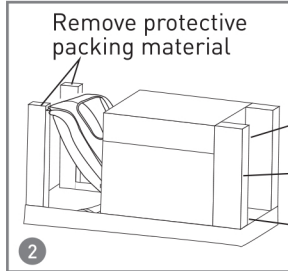

Take out the packing material.

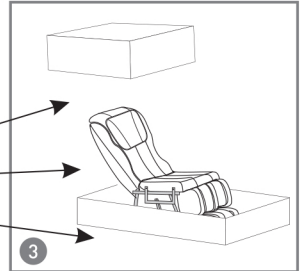

Install the pillow, backrest cushion, cushion and spare parts.

\*The spare parts include: remote control, holder, user manual wheel, power cord.

## Components |



BODY



SLIDE PANEL X 2



SLIDE PANEL LEFT X 1 / RIGHT X 1

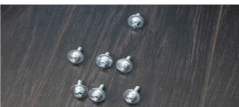

SHOULDER PANEL SCREWS X 3 EACH



SIDE PANEL SCREWS X 2 EACH

# CHAIR INSTALLATION

## | 2. Install the side board |

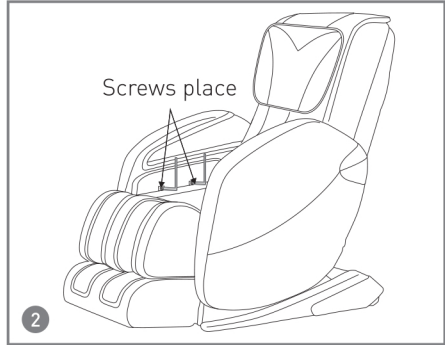
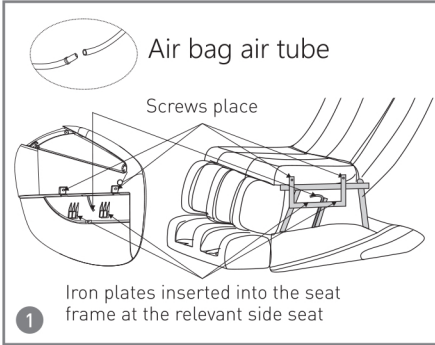

Remove the board from the carton, and take out the sideboard. Connecting the side plate trachea with the saddle lateral tracheal. The both sides trachea must to insert the end, in order to prevent air leakage.

Aligning the side plate hole and the massage chair hole, then inserted the plate into the corresponding side mount. To use screw driver lock-in screw, fixed. The other side also completed according to the above mentioned.

## | Both side panels installation x 2 |

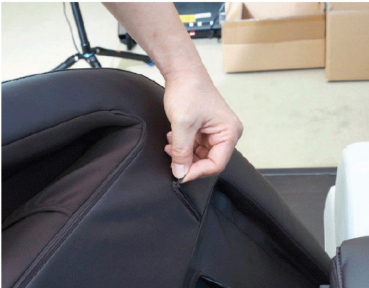

Open the Zip on side panel

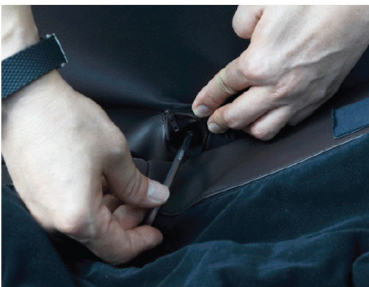

Close the zipper



Connect Airtubes



Tighten the screw make sure holes are straight to screws

## Tube Connection Check List

### 1. Incorrect tube location connection

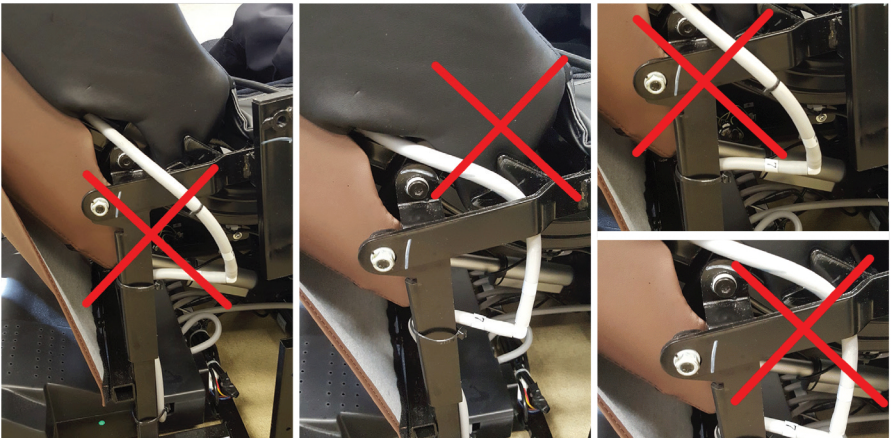

Tube must come out behind the visible frame, please see the image below

### 2. Correct tube location connection

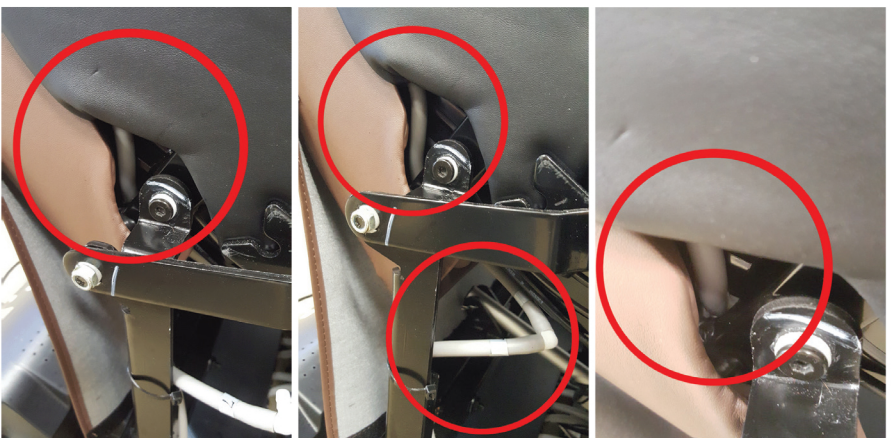

Please change the tube connection like the pictures shown above. If tube connection position is correct you don't need to change it.

# CHAIR INSTALLATION

## | 3. Install the shoulder airbag |

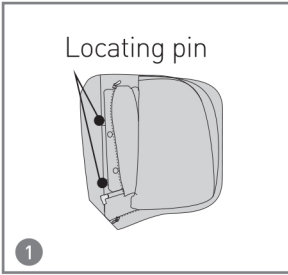

Find the 2 locating pin and screw holes.

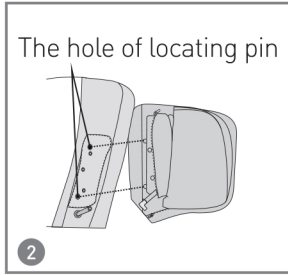

Using the locating pin insert into the chair back rest, then a cross screw driver to fix the Philip's head screw.

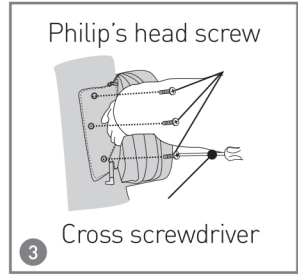

Connect the tube with tube connector on the chair.

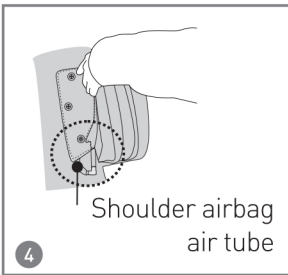

Zip up the opening after check each parts are secured.

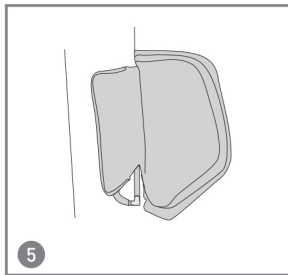

Double check the installation steps, smooth out any creases in the cushions.



Open the Zip on side panel



Connect Airtubes



Tighten the screws Make sure holes are straight to screws



Close the zipper

## CHAIR INSTALLATION

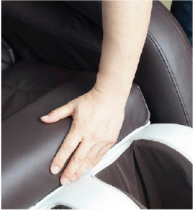

Arrange seat cushion neatly



Connect remote controller



Connect remote controller cable back of the chair



Connect main power cable

### 4. Place the massage chair in an open area |

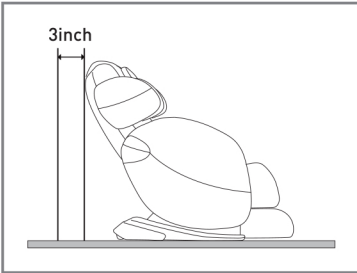

- Allow sufficient space around the chair for recline purposes.

- 3inch distance for the back side and 19.7inch in front of the foot rest.



## CHAIR INSTALLATION

### | 5. Moving the massage chair |

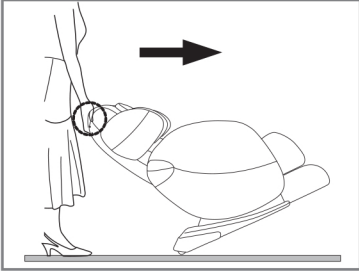

- As illustrated, push the back rest downwards and tilt chair on to its wheels at 45° angle. Slowly push and maneuver the massage chair to desired location. Lower massage chair slowly and smoothly until it is fully flat on the ground.

- CAUTION:**
- \*Do not move massage chair when occupied or in use.
  - \*Moving the massage chair may cause damage to the floors. Floor protection is recommended (e.g. rugs or carpet).
  - \*Do not drop or suddenly let go of the chair when moving as it may damage the chair.
  - \*Two persons are recommended when moving and extra care when handling the massage chair.

## | Remote Controller |



1. On/off Massage Chair
2. Zero Gravity Button
3. Auto Mode Switch Button
4. Yoga Stretching Button
5. Time Control Button
6. Heating Therapy Button
7. Location Adjust Button
8. Air Massage Intensity
9. Recline Adjustment
10. Foot Roller Button
11. Display Screen
12. Manual Program Button
13. Speed Adjustment
14. Area Adjustment Button
15. Fixed Spot Massage
16. Pause/Emergency Stop
17. Air Pressure Button
18. Roller Width

## | Function description of Controller buttons |



### Start or Stop massage chair

Press this button, massage chair will be ON, screen will be ON, User can choose auto or manual function to massage.

Press this button again, massage chair will be off, massage stopped, massage chair will come back to the original position, all buttons are inactive. When the chair returns to the original position the chair will completely shut off.



Press to temporarily pause the massage, chair will end idle mode. Press again to resume massage.



Press the button once, massage back and leg position to zero G1, press twice, the position to zero G2 twice, press third times, the position to zero G3, press fourth times, the massage chair return to original position.

Zero G1 → Zero G2 → Zero G3 → Original Position

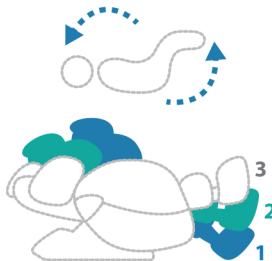

*PS: The position adjustment button have no function when the chair in the stretch program.*

## | Main Body Diagram (Rear) |



Manual massage technique button,

Kneading → Tapping → Dual → Rolling → Shiatsu → Off



Speed for Tapping, Kneading, Dual action and Shiatsu speed adjustment up to 3 levels.



"Area adjustment button" In manual mode, press to select between specific areas in the following order:

Back → Waist → Seat → Back & Waist → Waist & Seat → The whole body

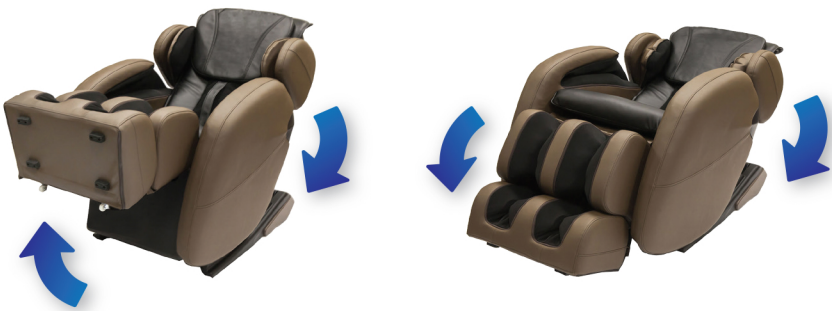

"Fixed Spot Massage" Press to stop the rollers at a particular area for a fixed point focal massage in manual mode.



Heating Therapy Switch on/off for back heating function.

# OPERATION GUIDE

## | Auto mode |



### Intelligent Automatic Programs

Press once to initiate the first of four intelligent automatic programs. Press repeatedly to switch between the programs, which are sequenced as follow:

SH-Chiro → Athlete → Refreshing → Anti stress → Rejuvenate → Off  
↑

## | This chair design with 2 sets of auto massage program |



Yoga stretching mode stretches your full body, LM-6800 Signature auto mode.



5-30 minutes interval adjustments, to select your desired massage duration time. 5 minutes additional intervals time for reach button press.



## | Annular functional area |



Air pressure massage area button. Each time you press this button, namely to lit the air pressure massage area on the screen. Press the button continued, there will be different parts of the combination of massage.



This button allows for you to control the intensity of the air bag on 3 different intensity levels.



Press this button to turn on/off the foot roller function.



Roller location adjustment: Hold the up or down arrow to move the massage rollers to the desired location.



Width: Press to adjust massage roller widths from narrow to medium to wide. Width adjustment is not available in kneading mode.



Press the button and hold on to adjust the foot rest independently.



Press the button and hold on to adjust the massaging position of back-rest and leg rest.

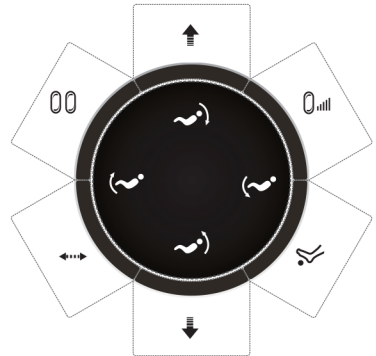

*P.S: The position adjustment button will not work when the chair in the yoga stretch program.*

# OPERATION GUIDE

## | 2 Display diagram |

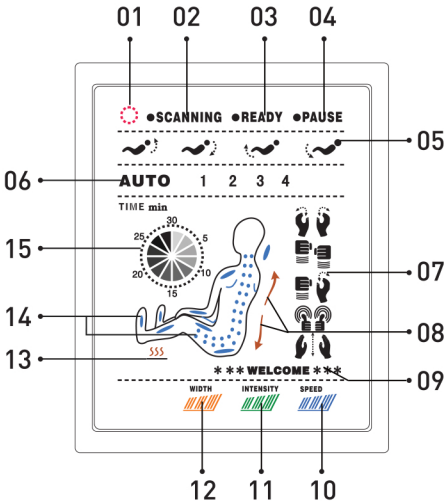

1. Massage chair is powered on.

● SCANNING

2. Massage chair is scanning the back and preparing for initiation.

● READY

3. Scanning is complete and ready for massage programs.

● PAUSE

4. Pause button has been pressed and chair is temporarily stopped.



5. Reclining position adjustment buttons are pressed and the back-rest or leg rest is moving.

**AUTO**

6. Display which automatic program is activated.



7. Display which massage technique is activated. Top to Bottom: Kneading, Tapping, Dual, Rolling, Shiatsu.



8. Display the direction of the massage rollers, moving upwards or downwards.

**\*\*\* WELCOME \*\*\***

9. Greetings message when preparing to start.

**SPEED**



10. Shows the massage speed levels, from up to 3 levels.

**INTENSITY**



11. Shows the massage speed level, from one bar to three bars illuminated.

**WIDTH**



12. Shows massage roller width, from narrow to medium, to wide.

**SSS**

13. Heating therapy function is on



14. Display the location of massage rollers and activate air bags.

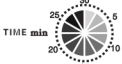

15. Display current time remaining in current massage program.

## | 3 After use |

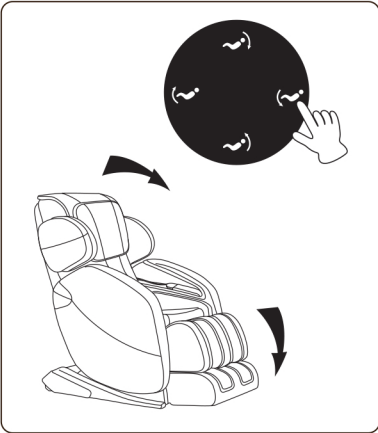

1. After the massage program is completed return the massage chair to upright position by turning off the massage chair.

Please check the surrounding prior to adjust the recline angle, paying special attention to children or pets that may be in close proximity.

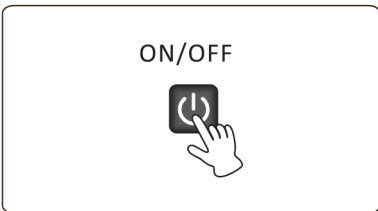

2. Press the power button to power off the massage chair and return remote controller to the storage area on arm pocket.

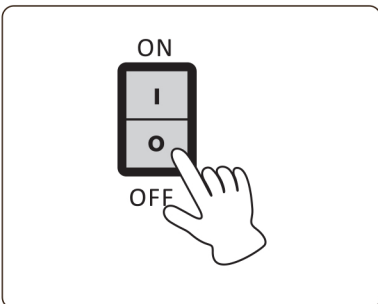

3. Turn off main power switch when you are not using the chair for a long period of time. Remove Plug from the power outlet to avoid accidents by kids and pets.

4. Do not operate with wet hands.

# TROUBLE SHOOTING

If the sounds or movements are not normal, please turn off the massage chair and remove the plug from the electric outlet. Please contact the customer service department for further assistance.

---

855.646.9500 / 1.714.388.2625, [service@kahunachair.com](mailto:service@kahunachair.com)

---

Problem	Solution
The massage chair is connected to power but is not functioning.	Check to see if the power plug is inserted or if the power outlet is functioning properly.
The remote controller is responding, but the massage chair is not functioning.	The massage chair may have automatically shut down due to overheating protection devices. Please turn off the power and allow the chair to cool off for 30 to 50 minutes.
Both the remote controller and massage chair are not responding.	The massage chair automatically turns into "full stop" mode when a massage program is completed. Please press the power button again to turn of the chair.



**KAHUNA CHAIR PRODUCT WARRANTY REGISTRATION**  
**<https://www.kahunachair.com/services/>**

---

| Use dry cloth to clean |

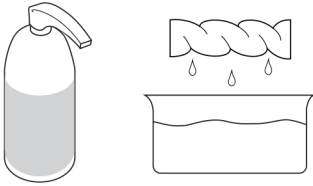
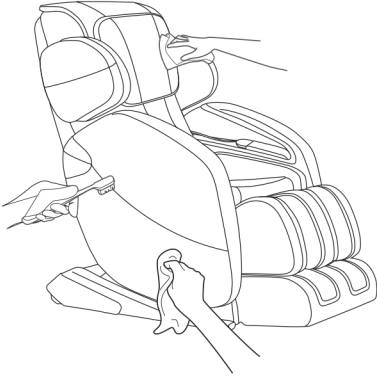

Turn off and pull out the plug before cleaning the massage chair, do not touch the plug with wet hands.

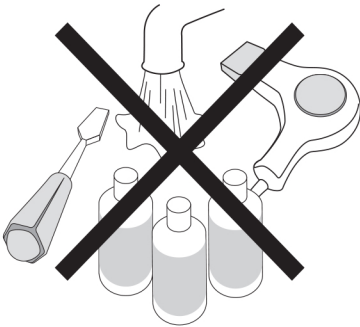

Prohibit using liquid cleaning products like water, alcohol, or other cleaning product to maintain a good quality.

## PRODUCT SPECIFICATIONS

Description	Specifications
Product Name	Kahuna Massage Chair
Model No.	LM 6800
Rated Voltage	110-120V~
Rated Frequency	50/60Hz
Rated Power Consumption	230 W Max.
Dimension (LxWxH) Inches	46 x 31 x 48 inches
Weight (LBS)	Net Weight: 200 lbs Gross Weight :220 lbs



**Product** Massage Chair

**Model** LM 6800

Distributed by AJX Distribution LLC

11125 Knott Ave, Suite D

Cypress, CA 90630

**Tel** 1-855-646-9500

**Email** INFO@KAHUNACHAIR.COM

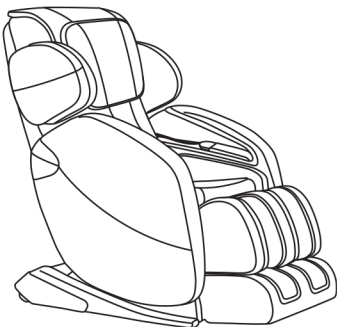

You can register warranty at [www.kahunachair.com](http://www.kahunachair.com)

---

INSTRUCTION MANUAL  
MODEL : LM 6800

Plaease read this user manual thoroughly  
prior to operating the massage chair.  
Store this booklet for future reference.